

Riser Gap Closure Pipe (meets O.B.C)

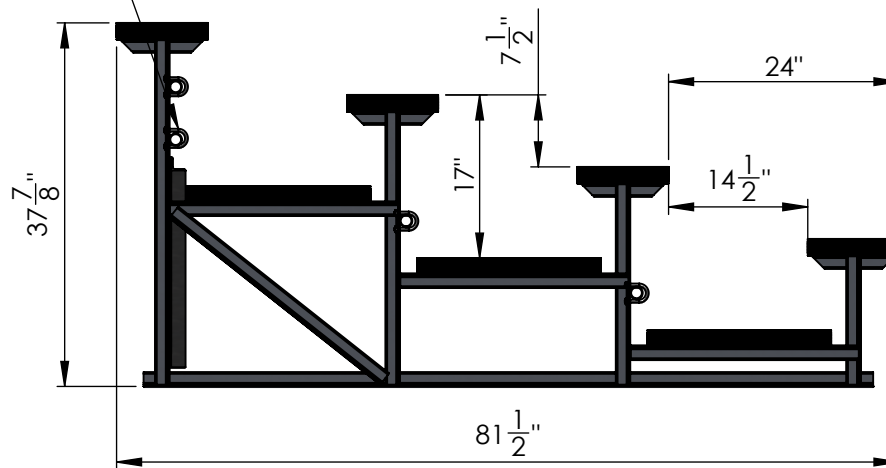

2x10 Anodized Aluminum

Double 2x10 Mill Finish Aluminum

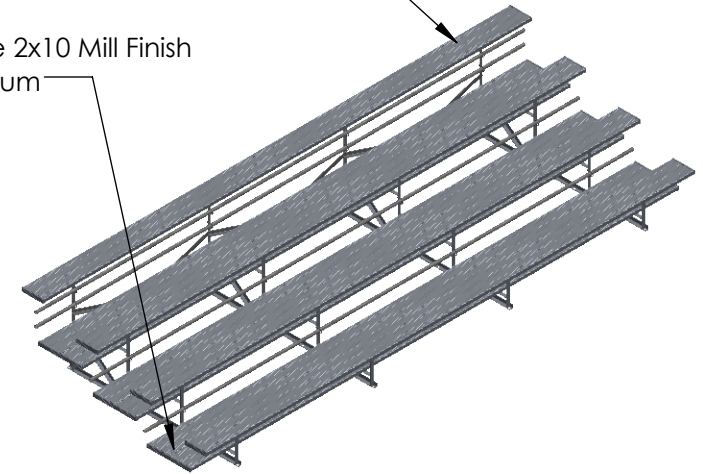

PRODUCT: 18' 4 Row Aluminum Bleacher

GENERAL NOTES / CONFIRMATIONS:

PROJECT:

DRAWN BY: R. Malantic

DATE: 2019-10-16

MODEL NO: FB18-4

CHECKED BY:



SHEET NO :

SCALE : xxx